

Tools Required

13mm, 16mm Socket

13mm, 16mm Wrench

Ratchet

Torque Wrench

Before You Begin

Read instructions thoroughly before installation.

Installation sequence: Mount brackets, position step bars, then tighten all

Prep Work: Clear any paint or debris from the factory studs.

Use proper tools to ensure a correct fit and save time.

Damaged or missing parts? Please take a photo and contact us for support. Professional installation would be highly recommended.

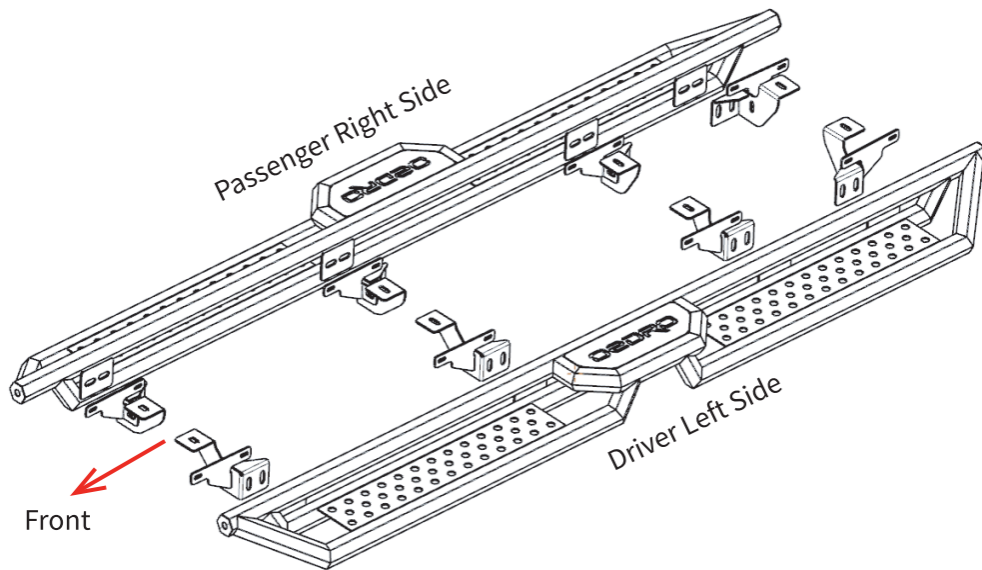

STEP 1:

1. Remove factory rock rails if equipped. 4 mounting positions each side.
2. Remove (8) M6 hex nuts on rocker panel and (4) M8 hex bolts on body frame.

External View of Passenger Side Mounting Positions

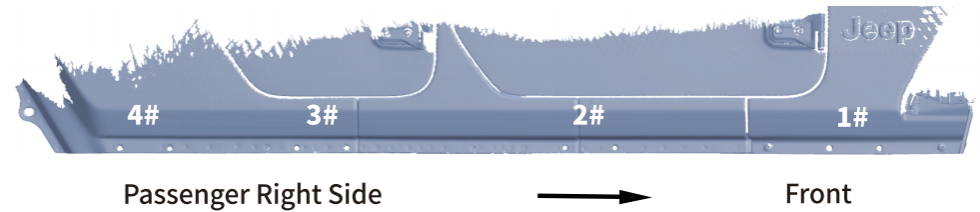

STEP 2:

1. Select the bracket corresponding to the positional encoding, e.g., for Passenger side Position **2#**, choose passenger bracket marked **2**.
2. Attach the mounting bracket to the factory inserts on body frame panel.
3. Secure the mounting bracket using (1) M8 hex bolt, (1) M8 lock washer, (1) M8 flat washer.

Note: DO NOT fully tighten at this time.

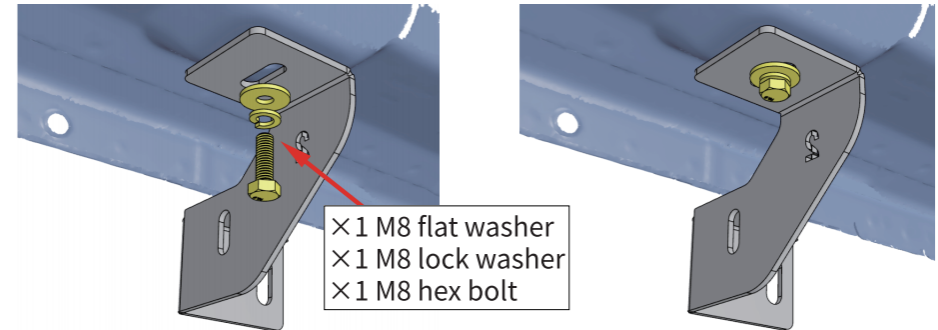

Passenger Right Side 2# Position as Shown.

STEP 3:

1. Attach the support bracket to the inner side of pinch weld and secure with (2) M6 carriage bolts, (2) M6 flat washers, (2) M6 lock washers, (2) M6 hex nuts.
2. Secure the support bracket to the mounting bracket with (1) M8 hex bolt, (2) M8 flat washers, (1) M8 lock washer, (1) M8 hex nut.

Note: DO NOT fully tighten at this time.

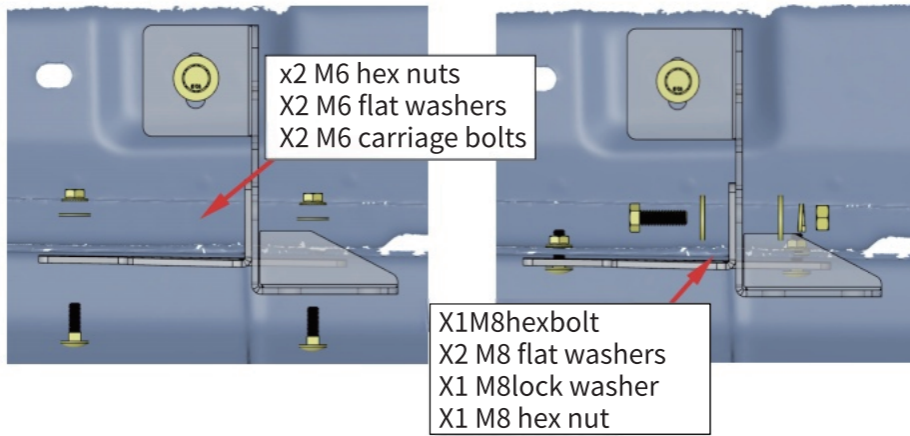

STEP 4:

1. Repeat step 2 thus 3 to install all brackets.
2. Check the direction of brackets refer to following figs.

External View

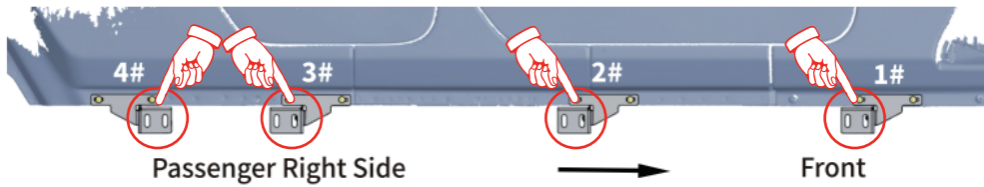

Internal View

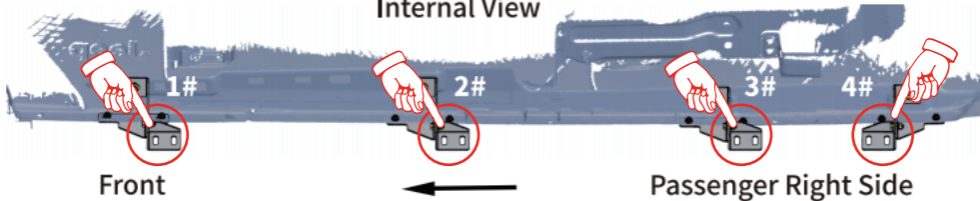

STEP 5:

1. With assistance. lift and attach the step bar to brackets. Secure the step bar on brackets using (8) M10 hex bolts, (16) M10 flat washers, (8) M10 lock washers, (8) M10 hex nuts.
2. Repeat to install the other side step bar.

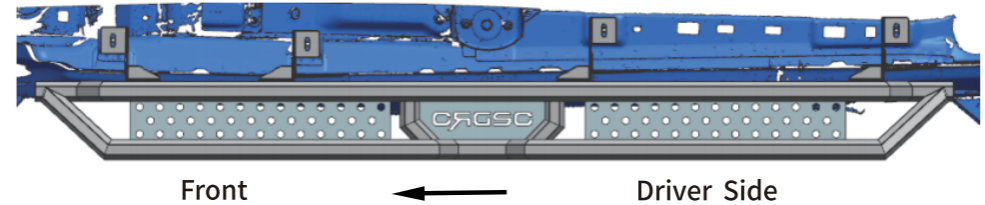
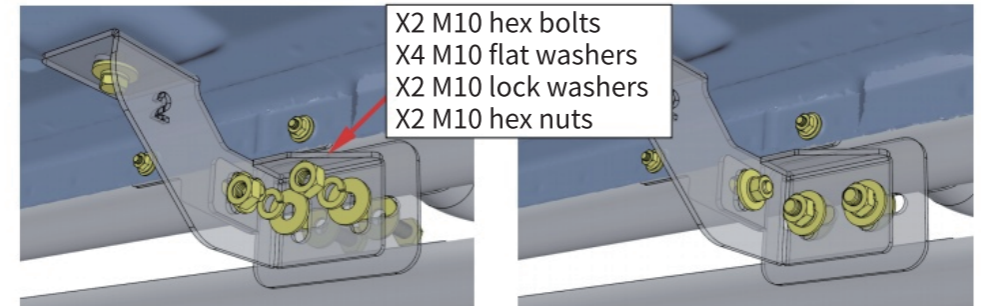

STEP 6:

1. Tighten M6 hex nuts with 7 ft. lbs. torque.
2. Tighten M8 hex bolts and nuts with 15 ft. lbs. torque.
3. Adjust the step bar to level and tighten M10 hex bolts and nuts with 31ft. lbs.torque.
4. After the step bar installed. periodic check to ensure all mounting hardware remains secure and tight.

Part List

Qty.	Description	Qty.	Description
① ×1	Front Driver Side Bracket (1)	⑪ ×16	M10×30 Hexagon Bolt
② ×1	Front Passenger Side Bracket (1)	⑫ ×16	M8×25 Hexagon Bolt
③ ×1	Center Front Driver Side Bracket (2)	⑬ ×16	M6 Carriage Bolt
④ ×1	Center Front Passenger Side Bracket (2)	⑭ ×32	M10×25 Flat Washer
⑤ ×1	Center Rear Driver Side Bracket (3)	⑮ ×24	M8×24 Flat Washer
⑥ ×1	Center Rear Passenger Side Bracket (3)	⑯ ×16	M6×18 Flat Washer
⑦ ×1	Rear Driver Side Bracket (4)	⑰ ×16	M10 Lock Washer
⑧ ×1	Rear Passenger Side Bracket (4)	⑱ ×16	M8 Lock Washer
⑨ ×4	Driver Side Front Center, Passenger Side Rear Support Bracket	⑲ ×16	M10 Hexagon Nut
⑩ ×4	Passenger Side Front Center, Driver Side Rear Support Bracket	⑳ ×8	M8 Hexagon Nut
		㉑ ×16	M6 Hexagon Flange Nut

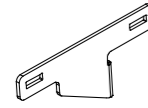

⑨

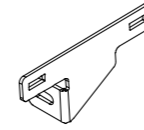

⑩

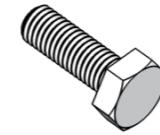

⑪

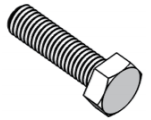

⑫

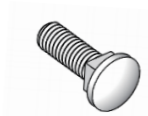

⑬

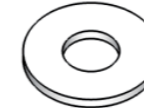

⑭



⑮

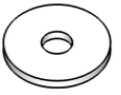

⑯



⑰



⑱

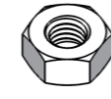

⑲



⑳



㉑

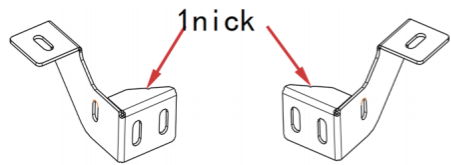

①

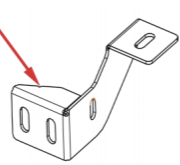

②

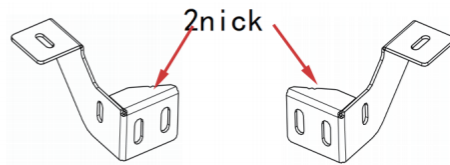

③

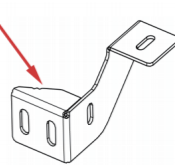

④

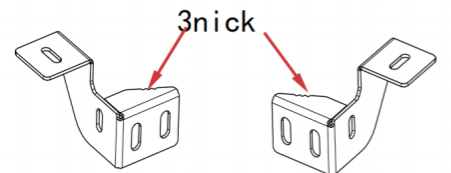

⑤

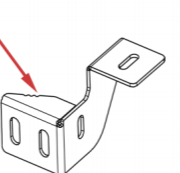

⑥

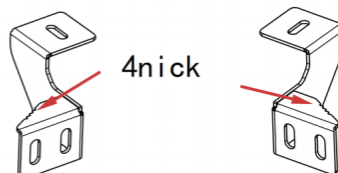

⑦



⑧