

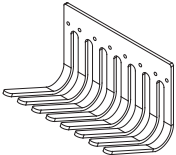

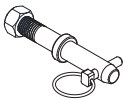

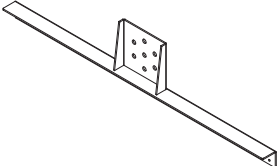

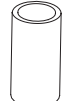

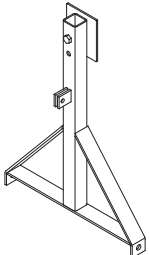

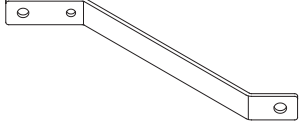

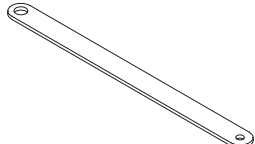
"IMPORTANT, RETAIN FOR FUTURE REFERENCE: READ CAREFULLY"

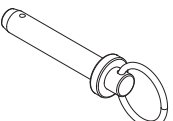
-  1. Confirm all parts are present prior to assembly.
- 2. Assemble on a flat, clean and soft surface.
- 3. Do not fully tighten screws until all parts are assembled.

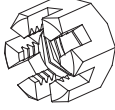
| Item no. | Reference Image   | Qty. | Item no. | Reference Image   | Qty. |
|----------|---|------|----------|---|------|
| <b>A</b> |    | X4   | <b>b</b> |    | X2   |
| <b>B</b> |   | X1   | <b>c</b> |    | X1   |
| <b>C</b> |  | X1   | <b>d</b> |  | X3   |
| <b>D</b> |  | X2   | <b>e</b> |  | X1   |
| <b>E</b> |  | X1   | <b>f</b> |  | X1   |
| <b>a</b> |  | X2   | <b>g</b> |  | X2   |

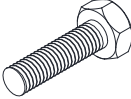
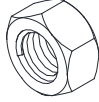
| Item no. | Reference Image   | Qty. | Item no. | Reference Image   | Qty. |
|----------|---|------|----------|---|------|
| h        |    | X1   | k        |  | X32  |
| i        |    | X32  | l        |  | X32  |
| j        |  | X32  |          |   |      |

1



Ⓐ 4pcs

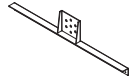

Ⓑ 1pc



Ⓘ 32pcs



Ⓙ 32pcs



Ⓚ 32pcs



Ⓛ 32pcs

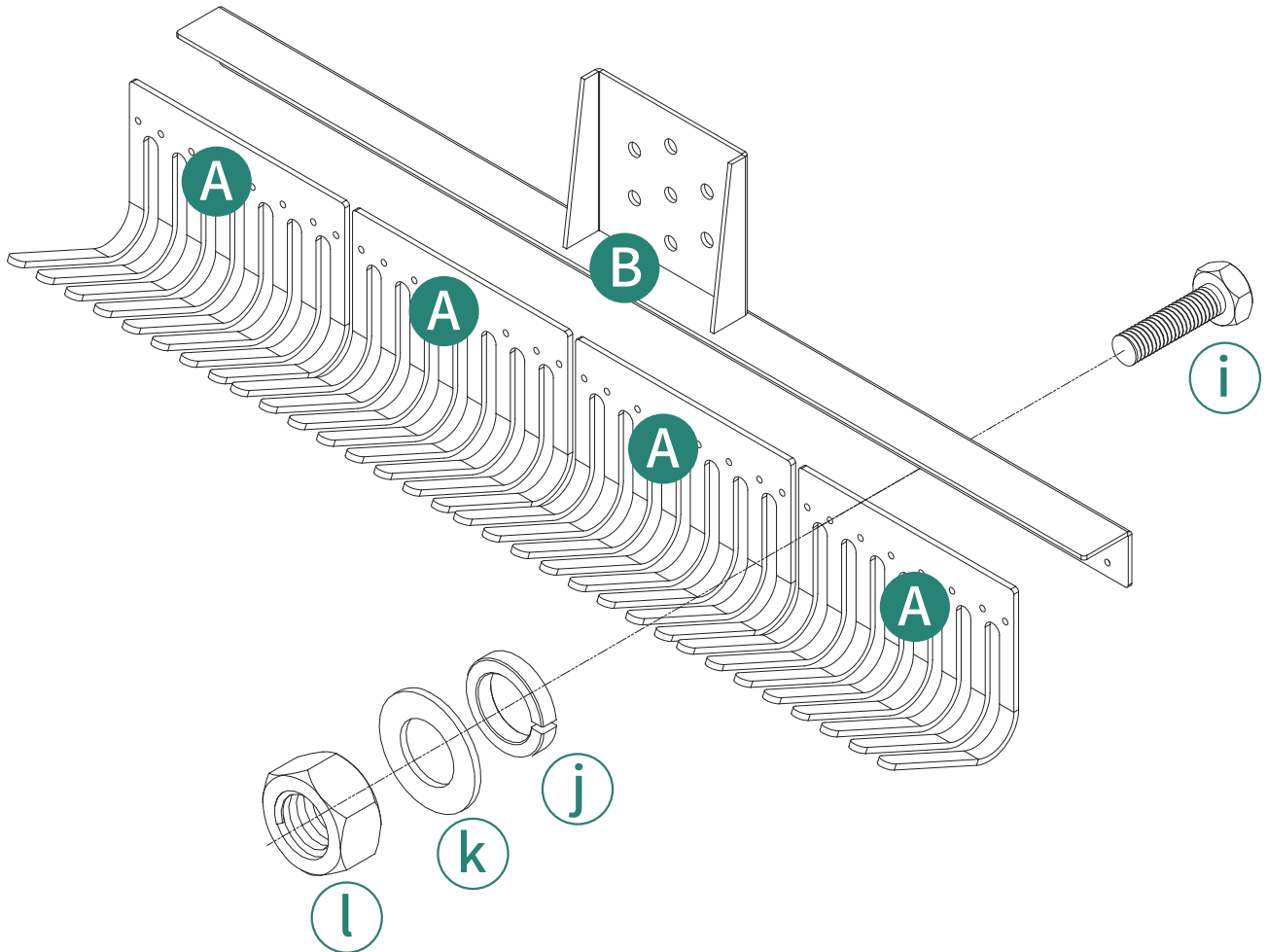

2

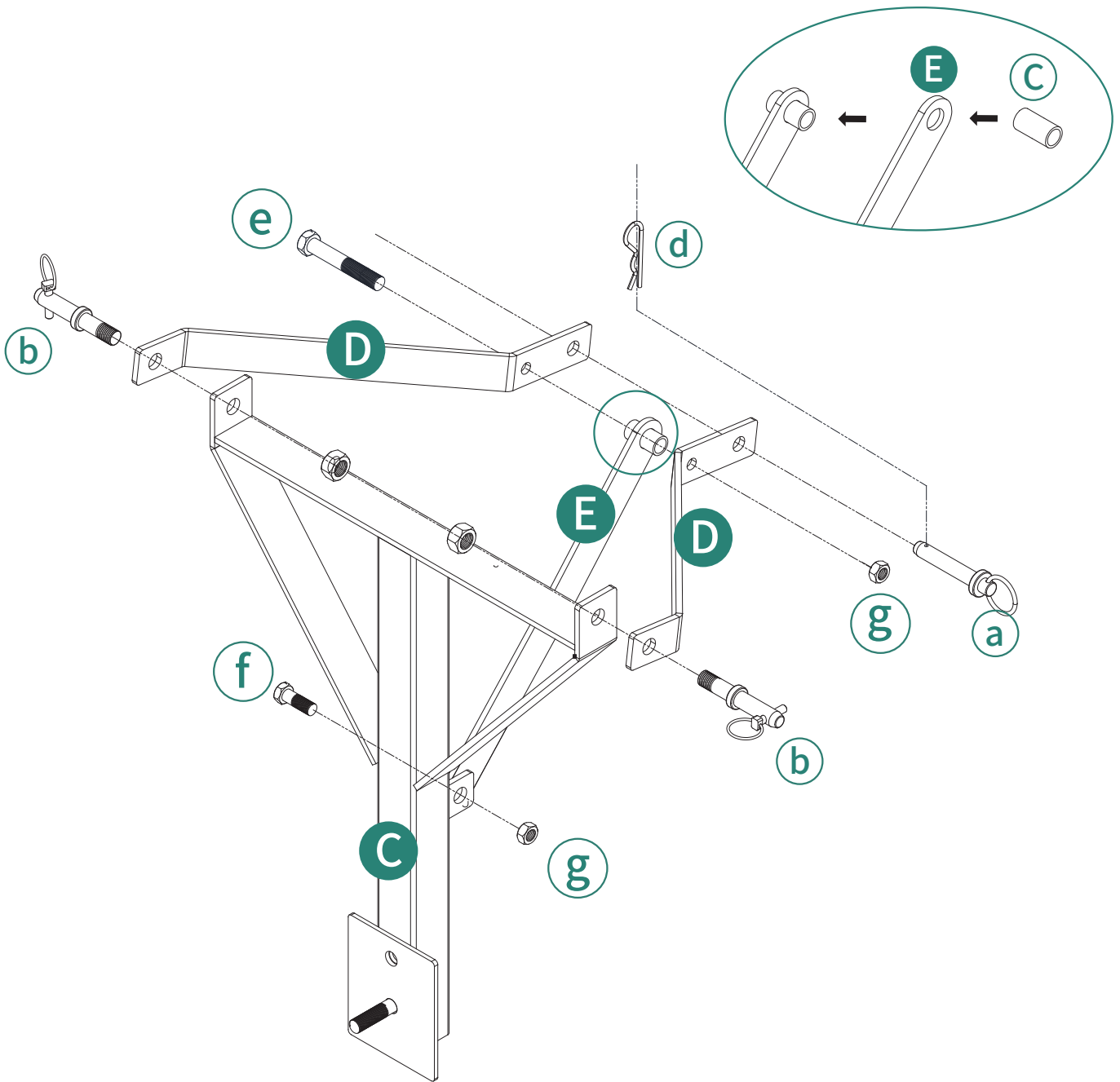
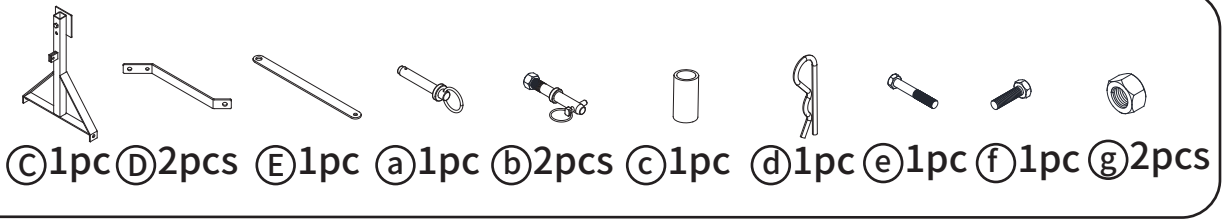

3



Ⓐ 1pc



Ⓓ 2pcs



Ⓗ 1pc

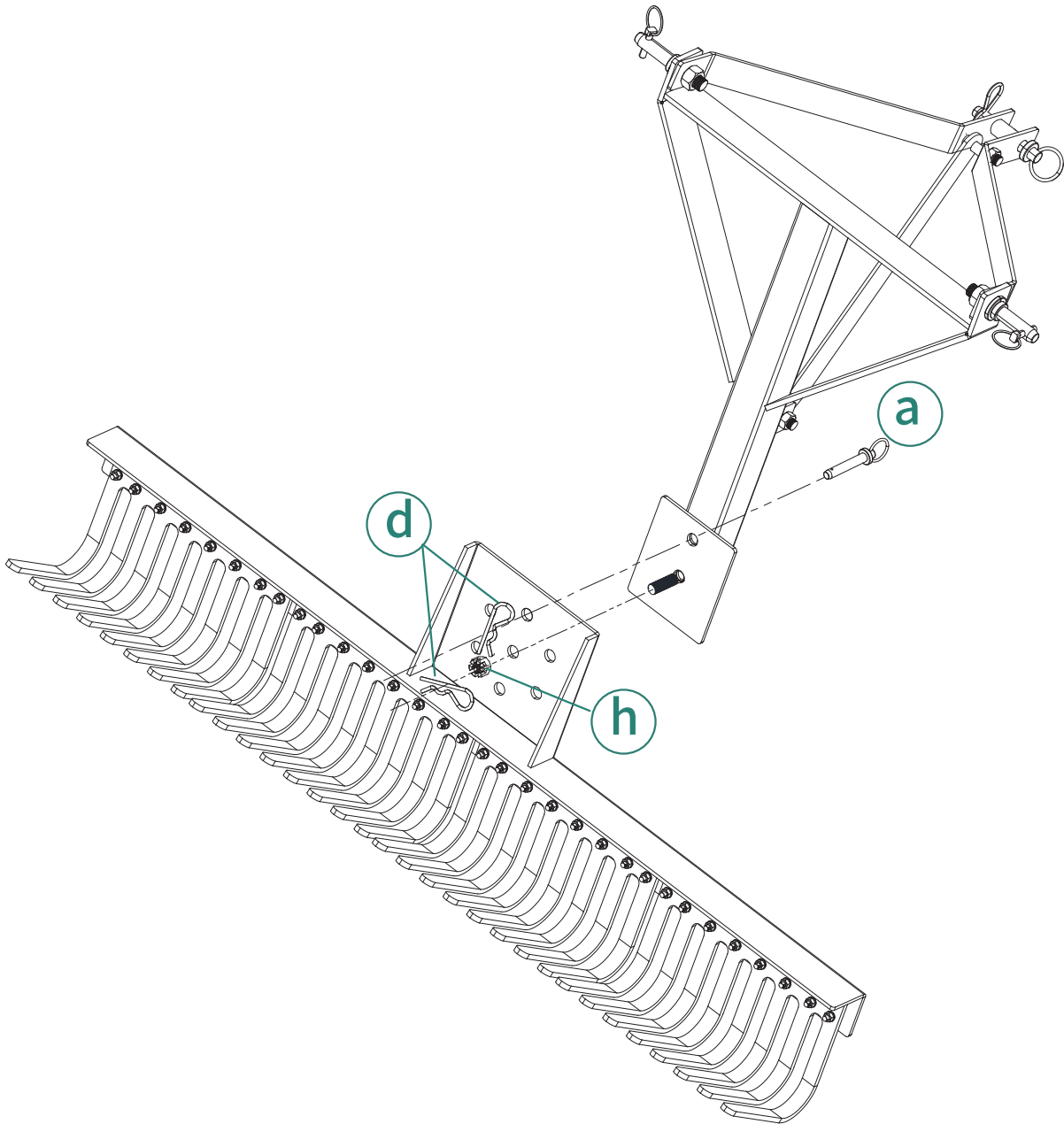

4



Installation Completed